

Working 160M From a Small Lot (and Larger Ones Too)

Jim Brown K9YC

k9yc@arri.net

<http://audiosystemsgroup.com/publish.htm>

What Happens on 160M?

- **Contests, mostly during winter, mostly CW, one SSB**
- **Rag-chewing, especially SSB**
- **JT65A (USB, set dial to 1838 kHz)**
- **Work DX year round**
 - **Summer has QRN, but best time to work VK/ZL, South America**

160M Is a Tough Band

- **Propagation variable, signals often not very strong, heavy QRN during the summer**
 - **Mostly a nighttime band, varies a lot through the night**
 - **During the winter, 800 miles or more is possible 2 hours before sunset, 2 hours after sunrise**

160M Is a Tough Band

- **Wavelength makes antennas more difficult**
 - **Quarter-wave vertical is 130 Ft**
 - **Half-wave dipole is 260 Ft, and it's “low” at 130 ft**
 - **Verticals need radials or a counterpoise, and they work best if they're fairly large**

What It Takes

- **Verticals rule on 160M**
- **Taller is better**
 - **Top loading is a very good thing**
- **Radials or a counterpoise are critical**
- **Don't let the perfect be the enemy of the good**

Good Vertical Antennas

- **A straight quarter-wave (Best)**
 - $\lambda/4 \sim 125$ ft at 1830 kHz with THHN
- **Inverted L (Good)**
 - Go straight up as high as you can with a wire, then bend the remaining wire to run horizontal to resonate it
- **Tee vertical (A bit better than L)**
 - Like an inverted L, but the top is extended in opposite directions

Inverted L

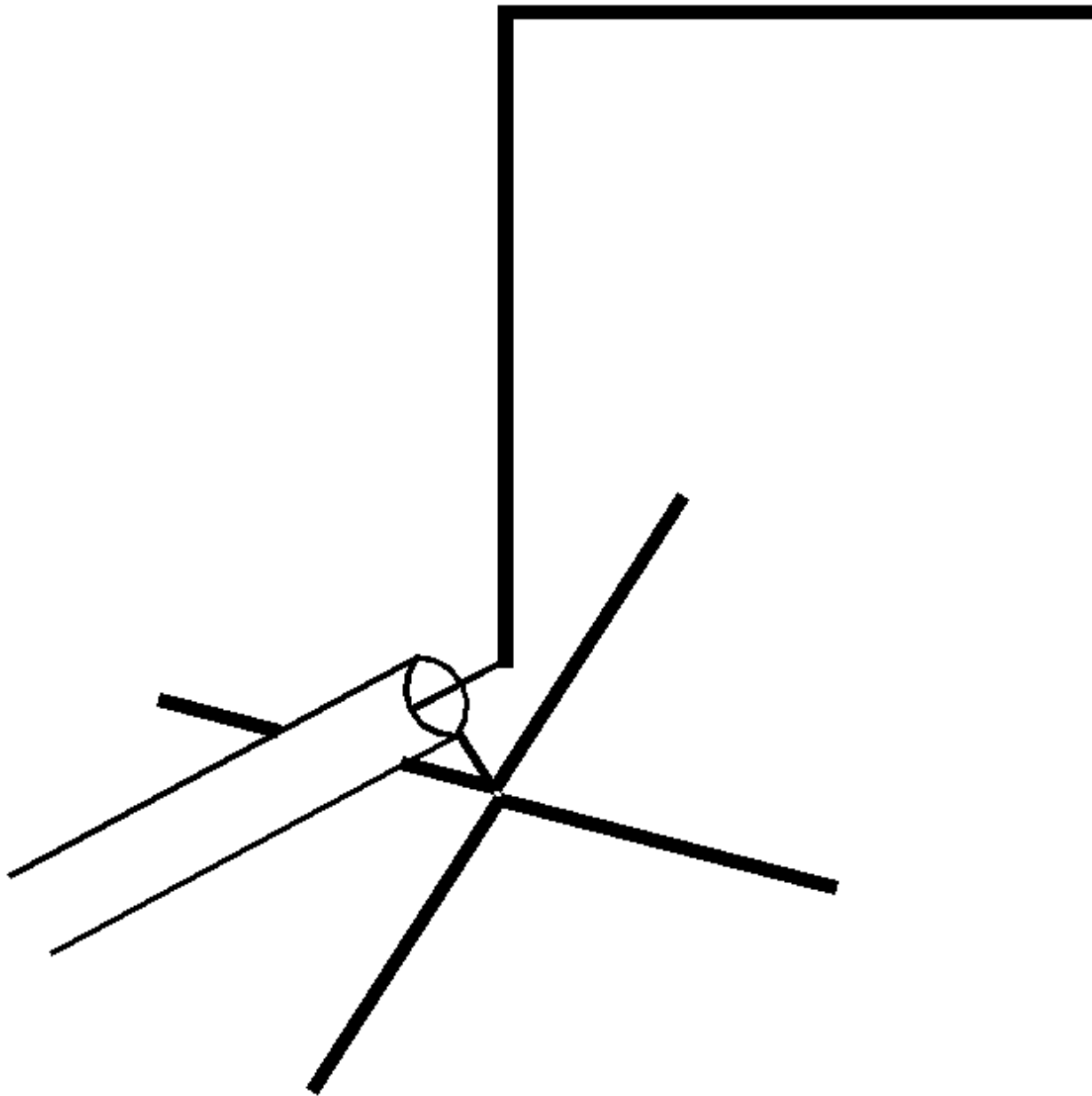

Simple Tee Vertical

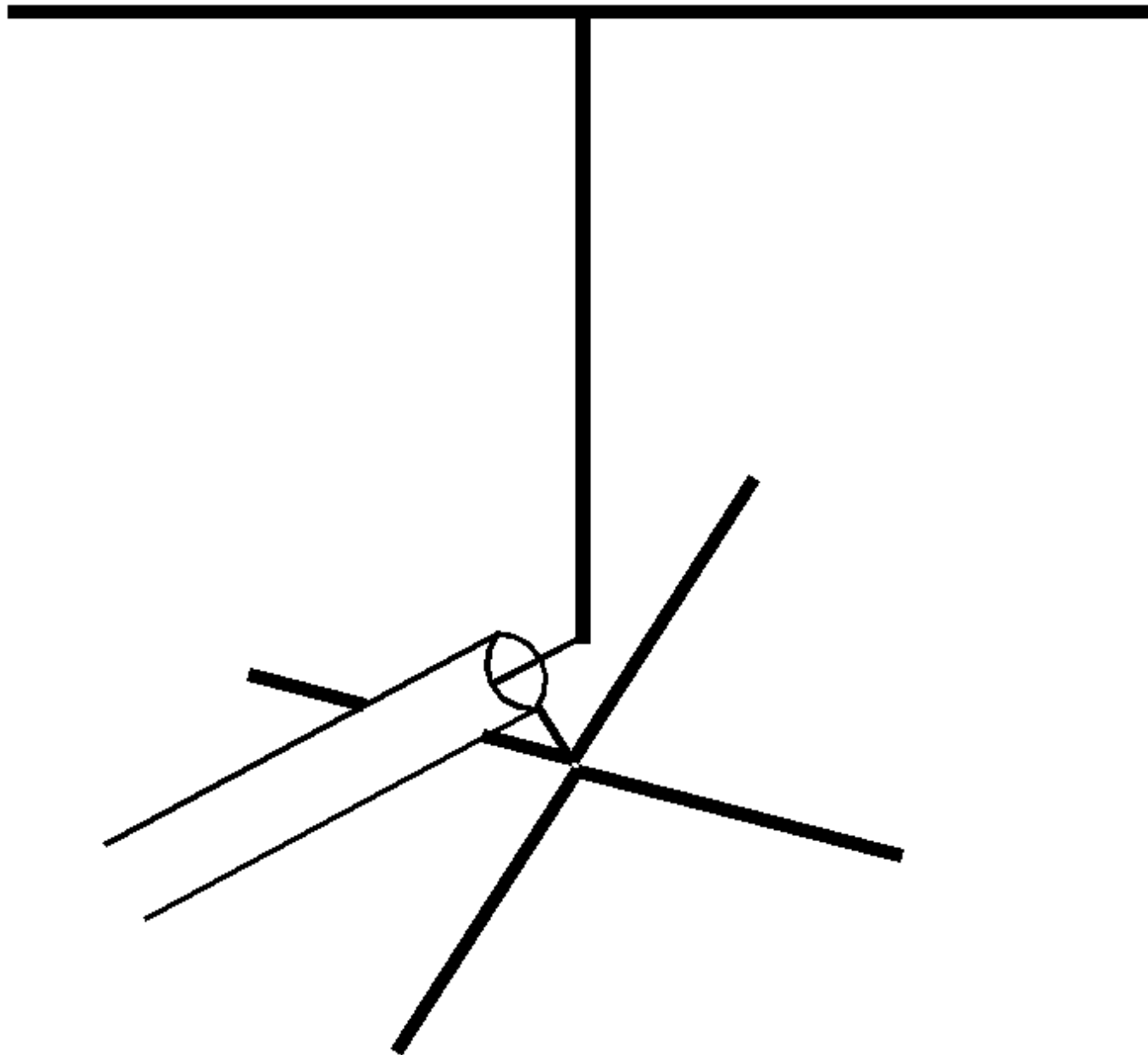

Other Vertical Radiators

- **Shortened vertical with multiple top loading wires (capacity hat)**
- **Shortened vertical with capacity hat and bottom loading coil**
- **Shortened vertical with bottom loading coil**
- **Heliacal wound vertical (K6MM)**

What is Loading?

- **Loading is the modification of a short antenna so it looks longer to the transmitter (often resonant)**
- **Add series inductance**
 - **At bottom or center of radiator**
- **Add horizontal wire(s) at the top**
 - **Wires provide capacitance to earth**

What is Top Loading?

- **Bend top over (inverted L)**
- **Bend top both ways (Tee vertical)**
- **Add multiple wires to top**
 - **Connect top guy wires to tower**
 - **Length of guys to first insulator provides top loading**
- **Yagis on top of a tower add top loading (not insulated elements)**

Why Top Loading Is Best

- **Current is what produces radiation**
- **Current in a resonant vertical peaks near the feedpoint, and is zero at the far end**
- **Adding inductance near a current peak “breaks it up” and reduces radiation**
- **Added resistance near feedpoint burns more power (R of inductor)**
- **Bottom loading at the base works, but burns some power**
- **Using bigger wire helps (#10 good)**

Making a Shorter Wire Resonant

- **Use insulated wire (1-2%)**
- **Make the conductor thicker**
 - **2 or 3 wires spaced 6-12 inches apart, connected top and bottom (1-2%)**
 - **Improves SWR bandwidth**
- **Not a lot, but every little bit helps**

Good Inductors Are Easy

- **Wind #10 THHN solid copper around 3-in or 4-in PVC conduit**
 - **Drill holes for wires at each end to hold in place**
 - **Extend wires to screws mounted to either end**
 - **Drill more holes for antenna wires**
 - **Loop antenna wire through holes, connect both wires at screws**

160M Loading Coil 7 μH



Feedpoint of Sloping Vertical



Good Inductors Are Easy

- **Use NEC to model antenna and predict inductance required to resonate the the antenna – or:
Use Vector Analyzer to measure feedpoint Z of existing antenna that's too short, export data to SimSmith and predict inductance**
- **Coil winding formulas in ARRL Handbook are very accurate**

How Much Top Loading?

- Use NEC to predict
- Even a very simple model will get you close for the radiator
- Connect the bottom of the vertical wire to ground, add a source at the bottom, add the top loading wire(s)
- Plot SWR in 10 kHz steps to find resonance
- Vary length of top wire(s) to set F_R

Top Loading Guidelines

- **Make the vertical as tall as you can for best efficiency**
- **Do what you can with left-over wire length at the top, either T or L**
- **Add loading coil at base if needed to make it easier to tune**
- **For an Inverted L, making the total wire length = $\lambda/4 = 130$ ft will get you close**

How Earth Affects Verticals

- Power is lost in earth very near the antenna before it can be radiated
 - Radials, counterpoise reduce this loss
 - Radials, counterpoise make the most difference with poor soil

How Earth Affects Verticals

- Radiated signal is reflected by the earth far from the antenna
 - Reflection adds to direct signal
 - Shapes the vertical pattern
 - Better soil helps low angle most
- Radials don't help the reflection, but they strengthen the radiated signal that gets reflected

What Kind of Soil Do I Have?

- **Most of the Bay Area has “Average” soil**
- **Most of the North Bay has “Good” soil**
- **Most desert and very rocky areas are poor to very poor soil**
- **You can measure it – see N6LF’s website for a simple method**

The Power of Earth Reflections

Salt Water

Very Good Soil

Average Soil

Rocky/Sandy Soil

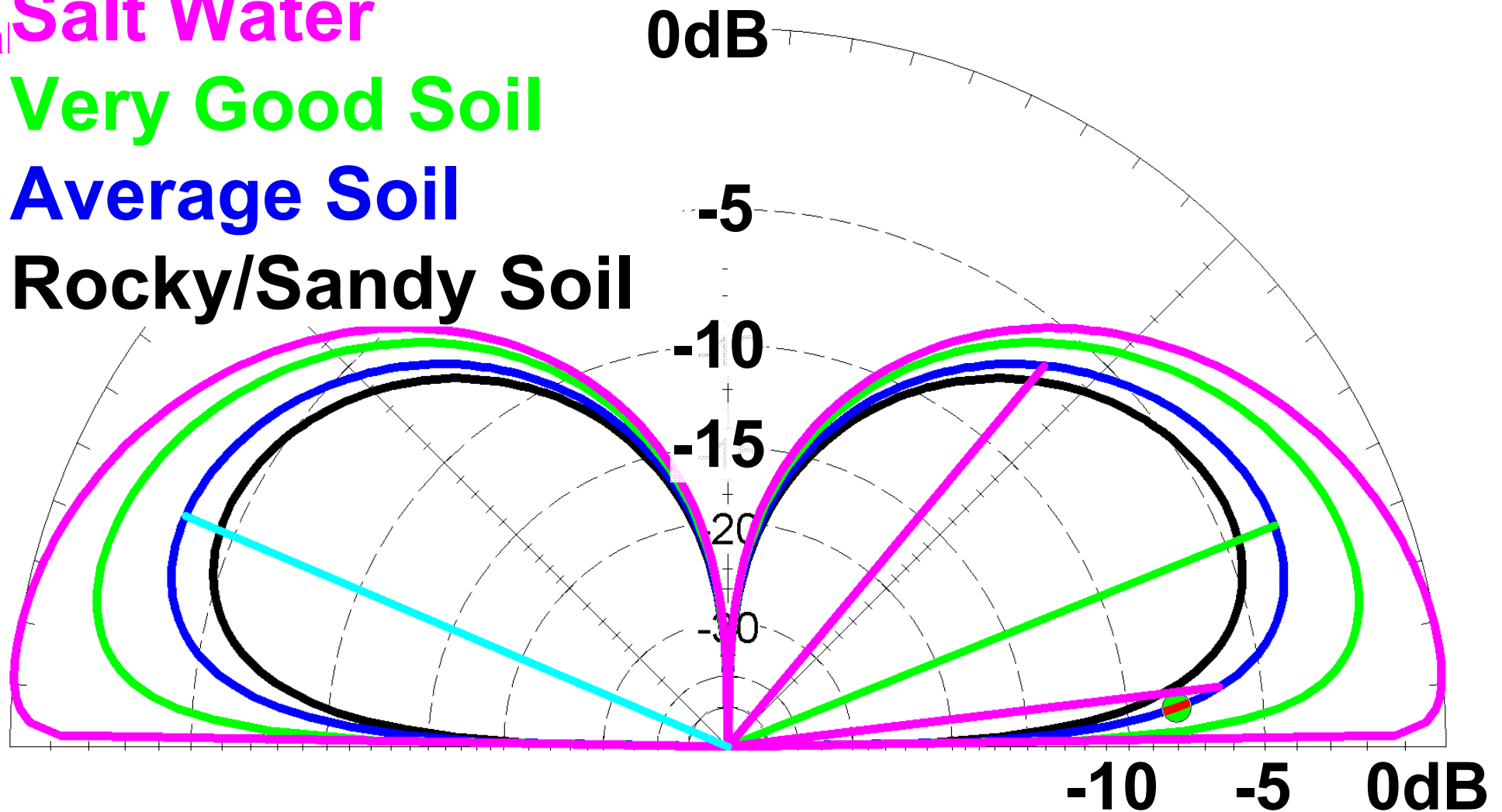

Vertical Pattern

Resistance Matters

- Radiation resistance (R_R) is the part of the feedpoint impedance that accounts for radiated power
- Mostly determined by vertical height of the radiator
- R_R is “good” resistance, larger is good

Radiation Resistance vs Height

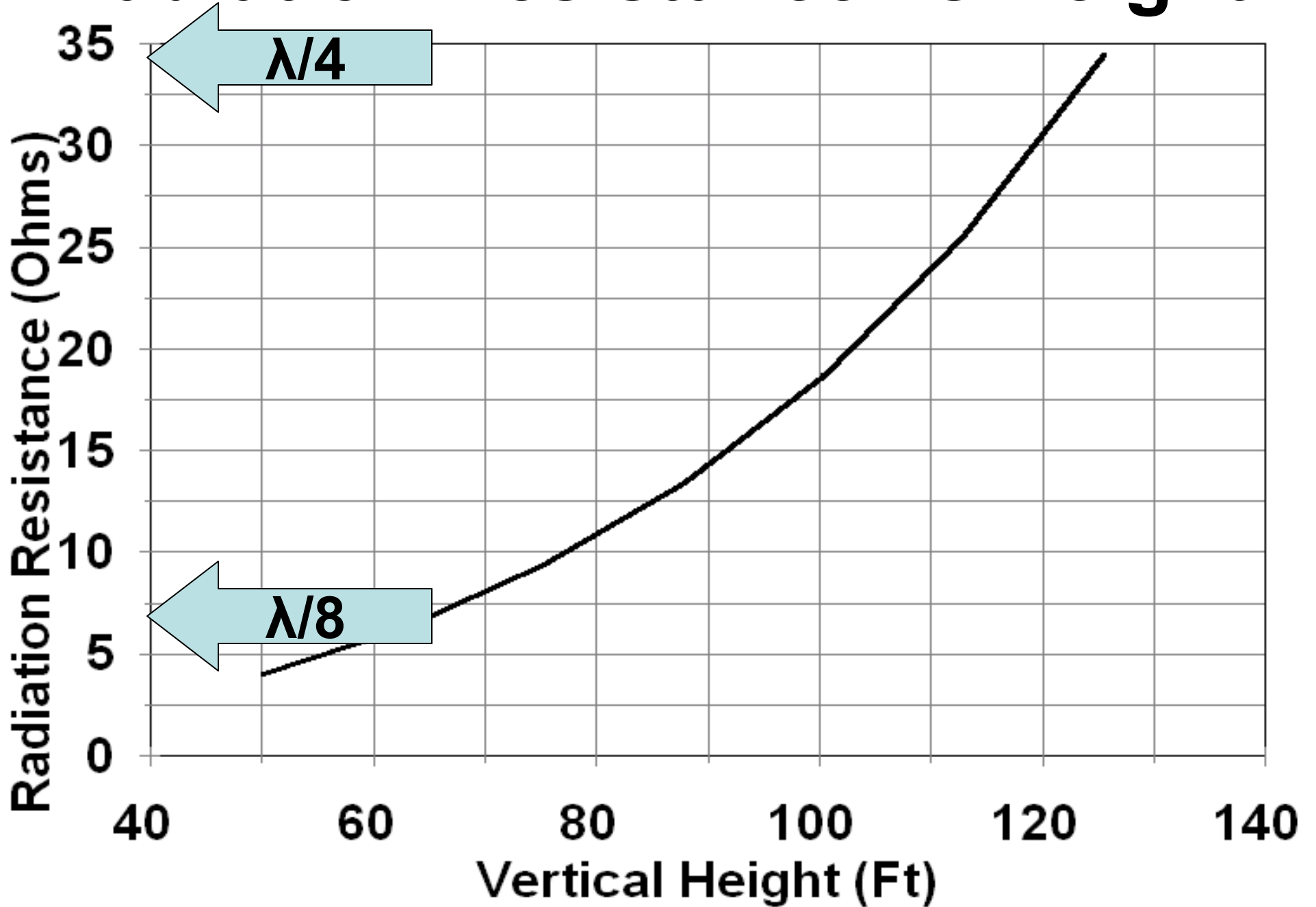

Resistance Matters

- **Ground resistance (R_G) combines with wire resistance (R_G) to burn transmitter power**

It's A Simple Series Circuit

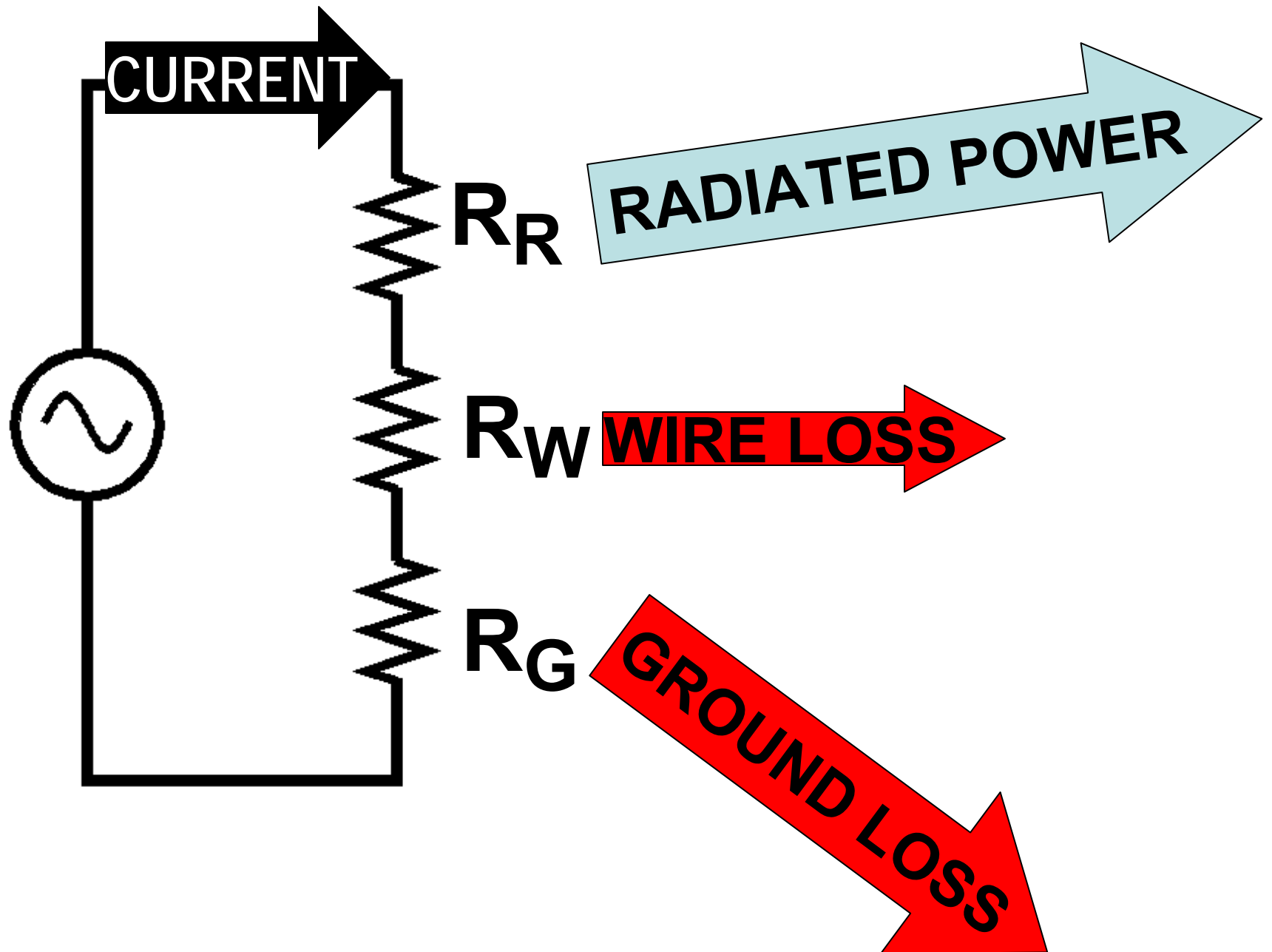

Loss Resistance Matters

- $P_{\text{TRANS}} = P_{\text{RAD}} + P_{\text{WIRE}} + P_{\text{GROUND}}$
- $P_{\text{TRANS}} = I^2 R_R + I^2 R_W + I^2 R_G$
- **Antenna Efficiency = $R_R / (R_W + R_G)$**
 - If $(R_W + R_G) = R_R$, loss is 3dB
 - If $(R_W + R_G) = 2R_R$, loss is 6dB
- **We want large R_R , small R_G**

Ground Resistance

- **Depends on the nature of the earth around the antenna**
 - **We can't change it except by moving**
- **Depends on the radial system**
- **Make R_G smaller by using**
 - **more radials and longer radials**
 - **a good counterpoise**
 - **a ground screen**

Tall Antenna, "Good" Radials

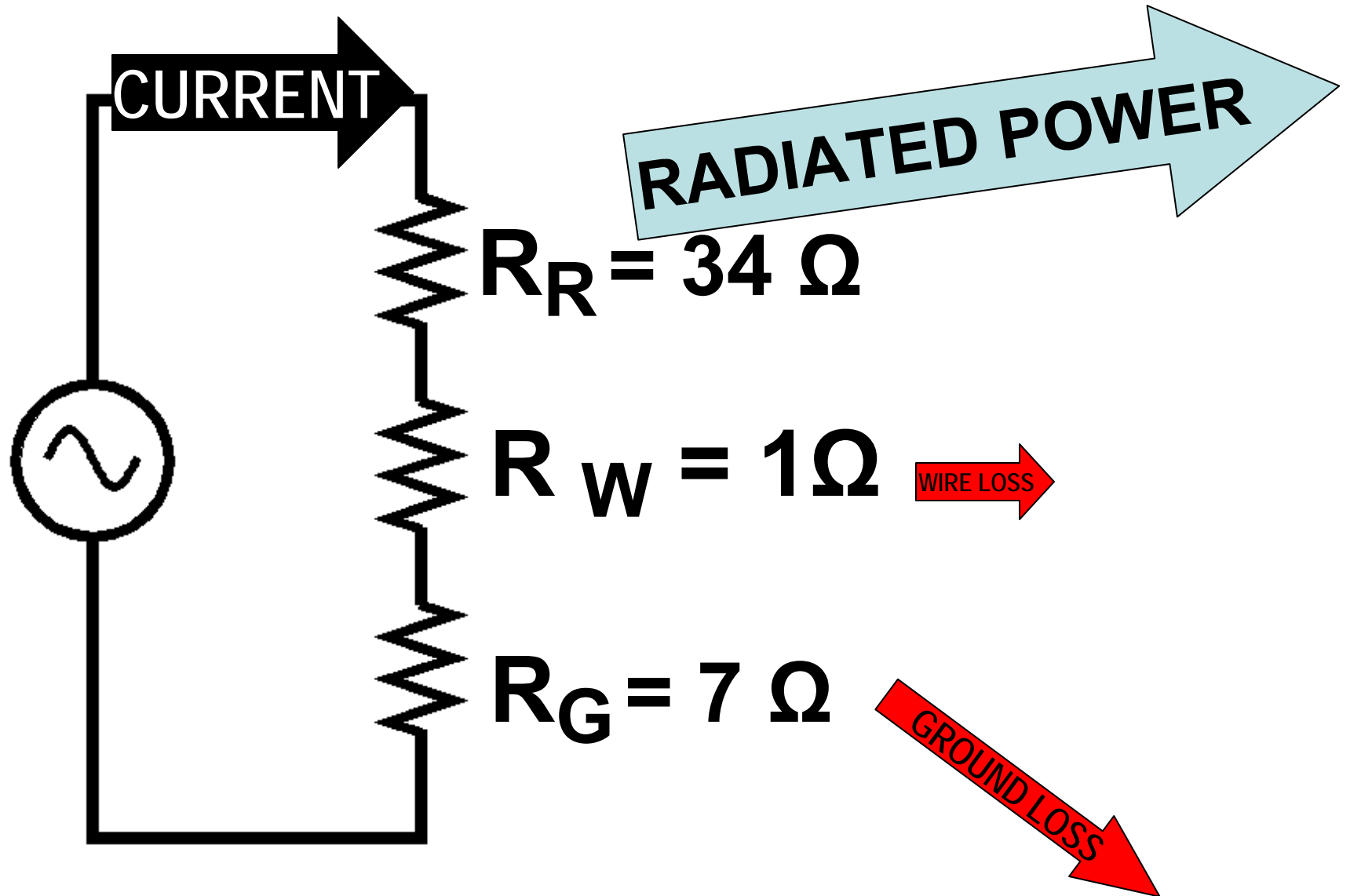

Loss = 0.8dB

Tall Antenna, "Good" Radials

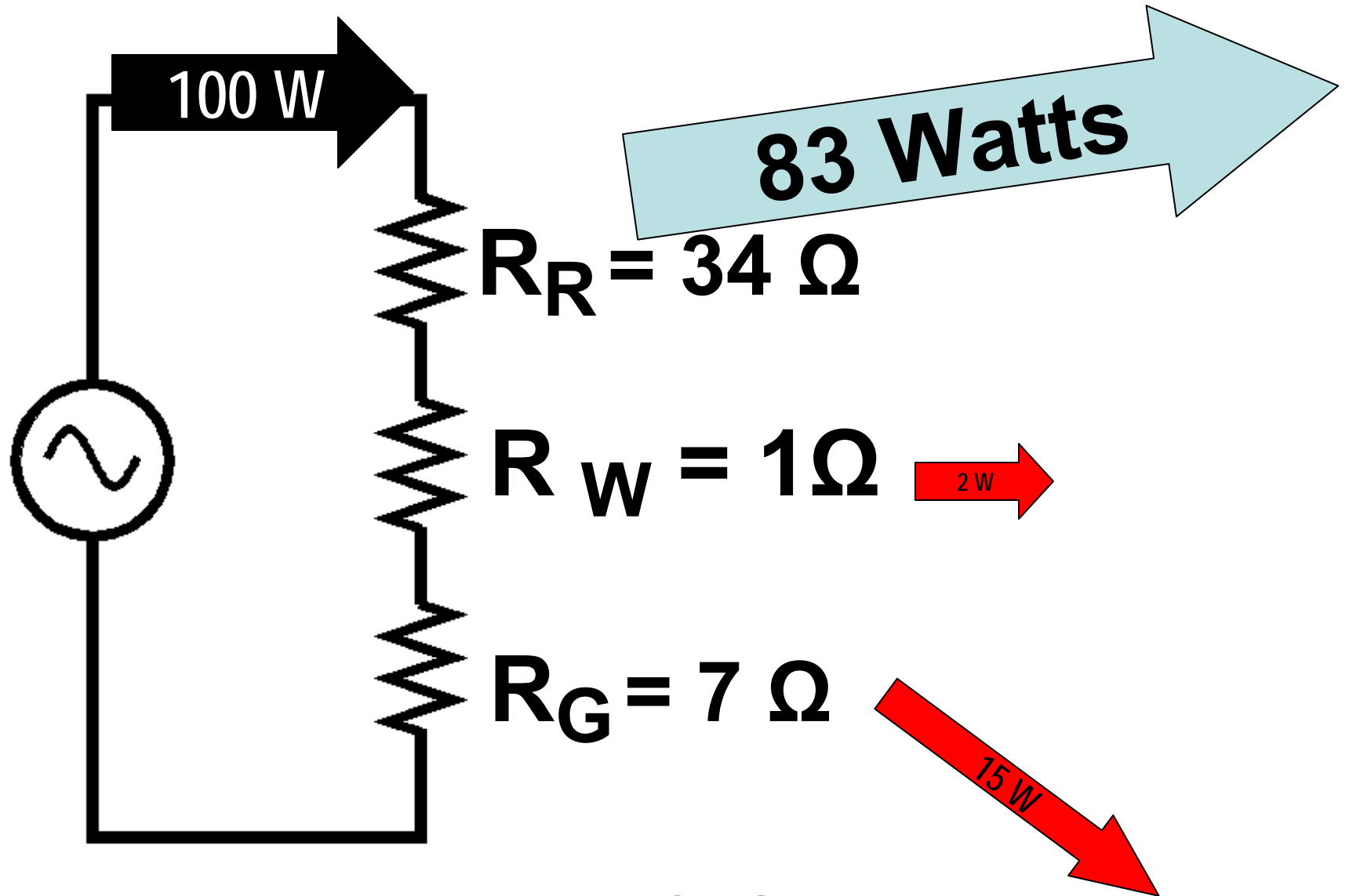

Loss = 0.8dB

Short Antenna, Limited Radials

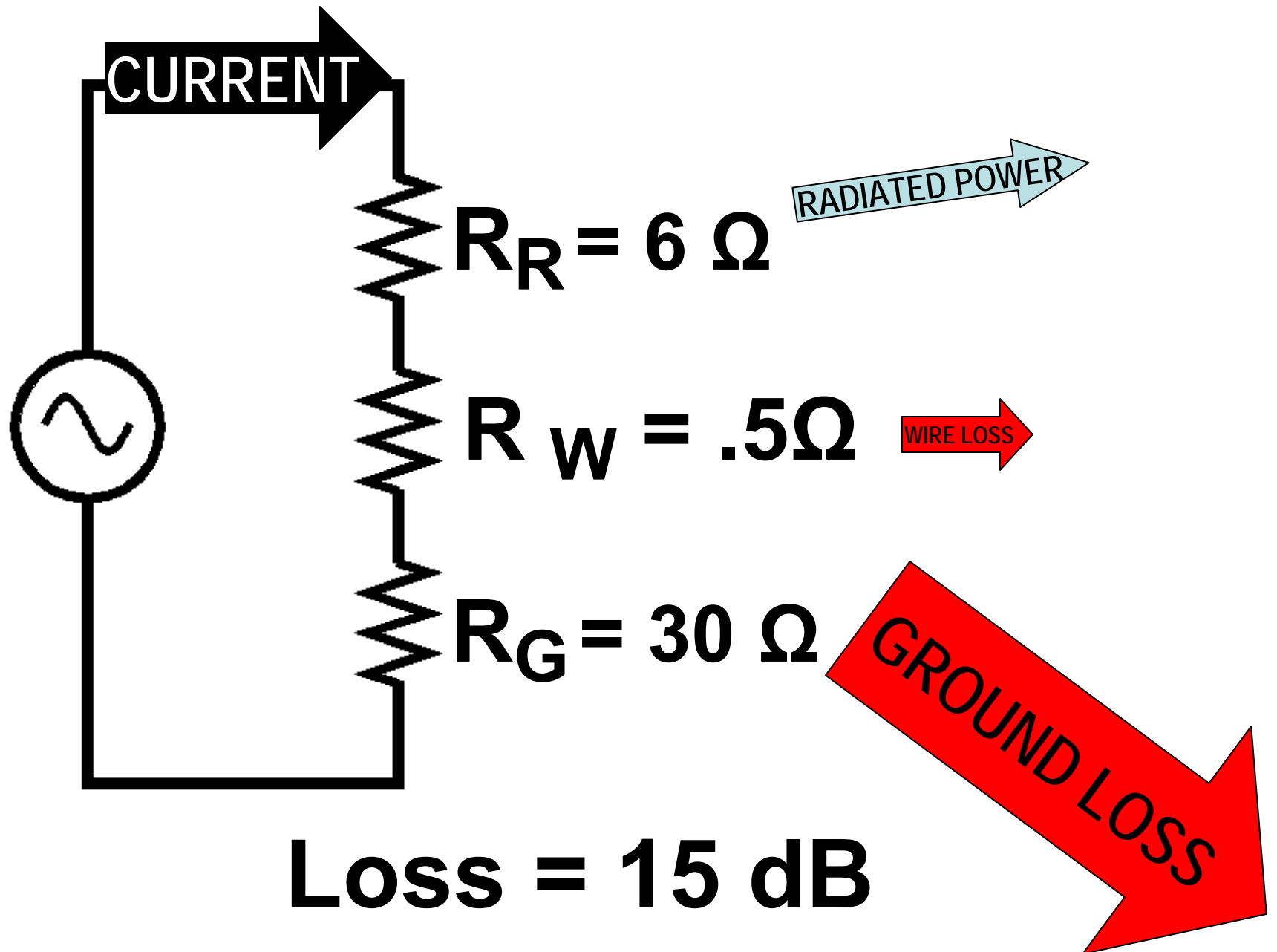

Short Antenna, Limited Radials

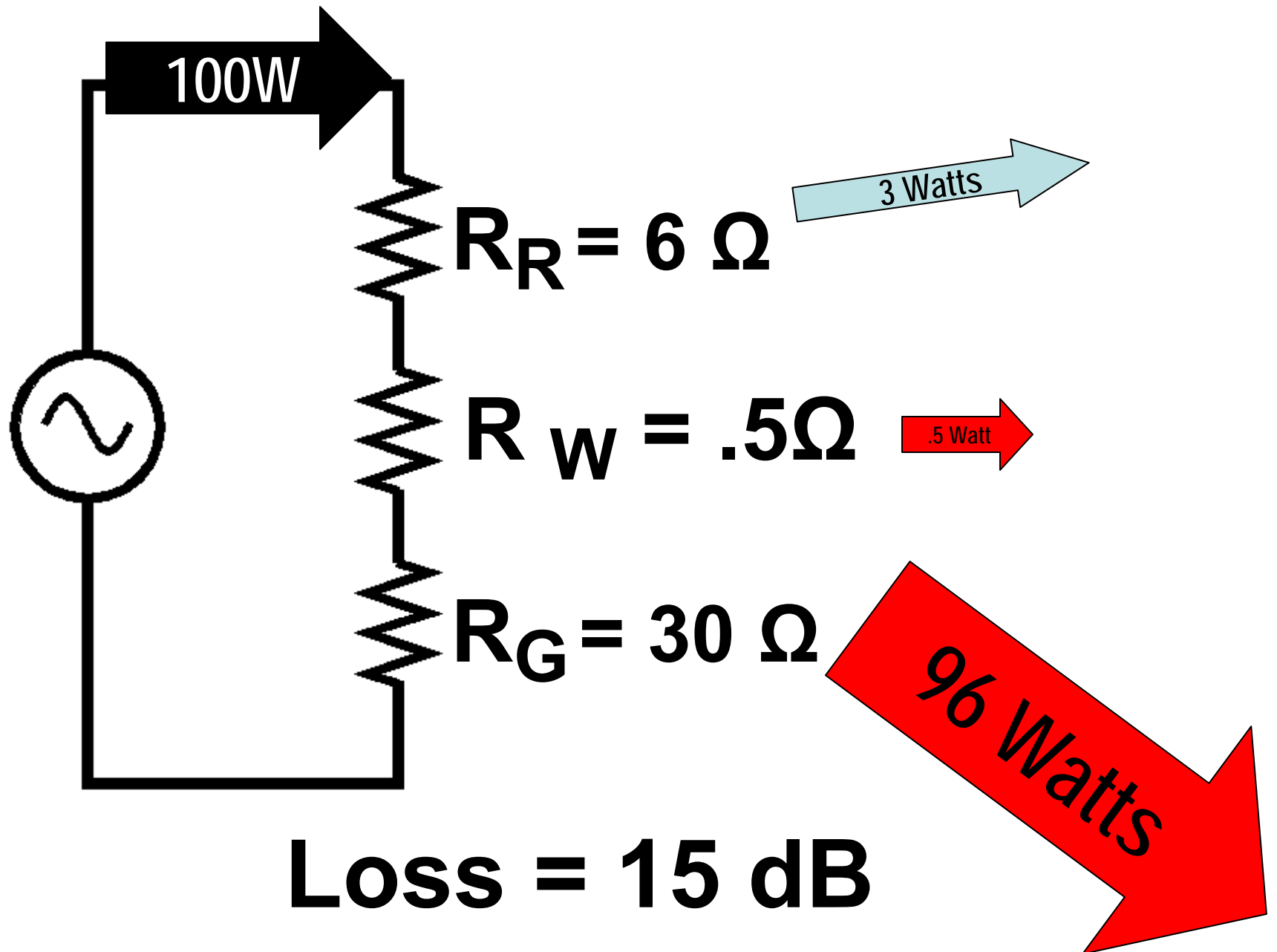

Typical Loss Resistances

- R_W of #10 wire $\sim 1 \Omega$ for $\lambda/4$
- It's hard to get R_G below 10Ω with a lot of space, and 20Ω is tough on a small lot
- So – we usually ignore R_W and concentrate on trying to make R_G smaller and R_R larger

Why Radials or Counterpoise?

- Earth is a relatively poor conductor – that is, it's a (very big) resistor
- Even the best connection to earth is bad for an antenna – it drives current to that lossy earth
- Current in lossy earth burns transmitter power ($P_G = I^2 R_G$) before it can be radiated

Why Radials or Counterpoise?

- **An ideal radial system:**
 - **shields** the antenna from the earth
 - provides a path for return **current**
 - Provides a return path for fields produced by the antenna
- **A counterpoise provides only the return current path**
 - More about counterpoises later

Why Radials or Counterpoise?

- **With no radials or counterpoise, the outside of the coax forms a single radial or counterpoise**
 - **It's better than nothing, but not very effective**
 - **And it can put RF in the shack**

Guidelines for All Radials

- **Insulated wire holds up longer**
- **#18 minimum size for durability**
 - **Large spools hard to buy**
- **#14 THHN (house wire) works well**
 - **Mass market items often less expensive and easy to find**
 - **Discount for 6 or more spools at big box stores (Home Depot, Lowe's)**

On-Ground Radial Systems

- **Best** – up to 60 $\lambda/4$ wires (shortened by V_F to 100 ft) laid out as symmetrically as you can
- **Very Good** – many wires on the ground, lengths can be random
- **Symmetry** is good, but most radial systems must be shorter in some directions because they run into buildings, roads, property lines

Resonant Radial Length

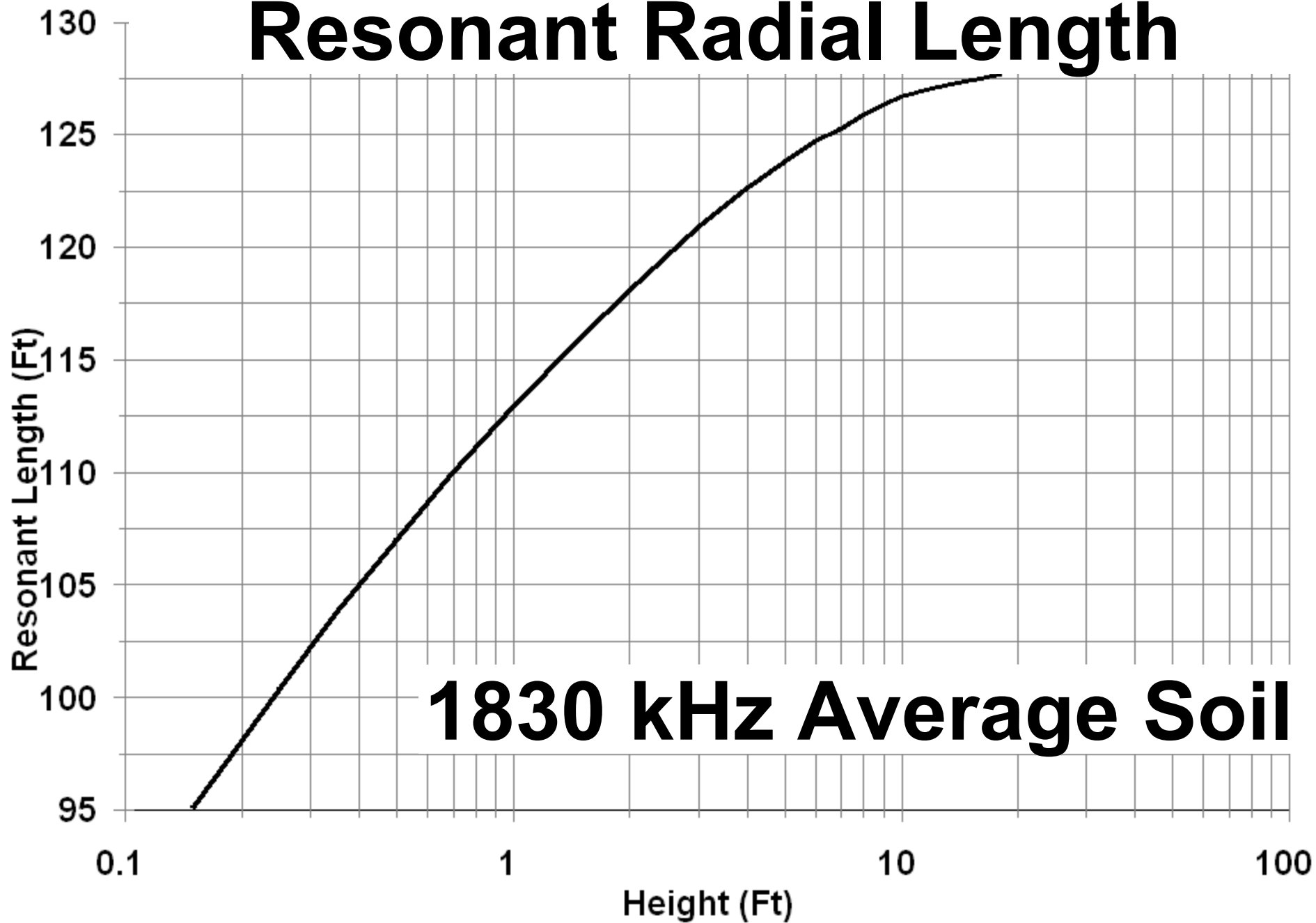

1830 kHz Average Soil

Velocity Factor (V_F) vs Height

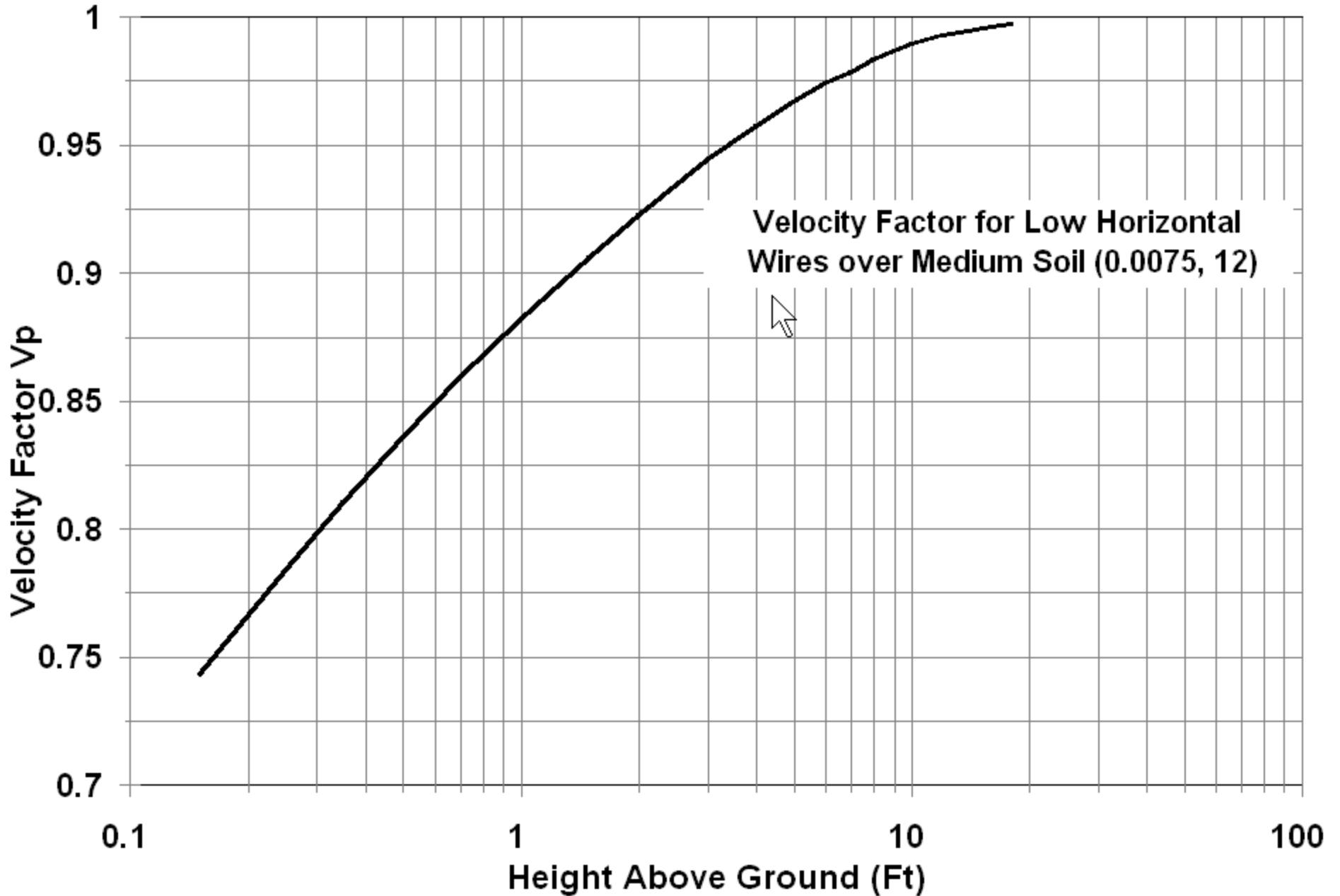

Traditional Radial Systems

- 60 radials, each 100 – 125 ft long, arranged symmetrically around the feedpoint**
- That requires that we can rig our antenna in the center of open space with a 100 ft radius**

Traditional Radial Systems

- **60 radials, each 100 – 125 ft long, arranged symmetrically around the feedpoint**
- **That requires that we can rig our antenna in the center of open space with a 100 ft radius**
- **Show of hands – how many can do this?**

Resonant Radials are Great, But:

- Few city and suburban lots are larger than 130 ft x 40 ft, most are smaller, and that includes a home and garage**
- So most of us need a plan B (or C)**

Three Limited Space Options

- **Use as many radials as you can, each as long as will fit your space**
- **Use a ground screen made from galvanized hardware cloth**
 - **as large as can reasonably fit in the space around your antenna**
- **Use a K2AV folded counterpoise**
 - **66 ft long, centered at base of antenna, suspended at 8 ft**

On-Ground Radial Guidelines

- **Don't use radials longer than the vertical height of your antenna**
 - **Current distribution makes them not work very well**
 - **If you want to use more wire, add more radials, not longer ones**

On-Ground Radial Guidelines

- It's better to have more shorter radials than a few long ones**
- You can never have too many**
- Start with what you can do now, add more when you can**
- Resonant length matters if you have only a few radials (<12), much less important if you have many**

Should Radials Be Buried?

- Performance is about the same buried or laying on the ground**
- Buried radials tend to be more stable with changes in weather**
- Burial may offer some protection**
- Radials laid on the ground will be overgrown by grass and brush**

Cost/Benefit Analysis

- **Question #1: What radial layouts give the most bang for the buck?**
- **Question #2: How much bang do I get from my buck?**
- **Question #3: How much is enough?**
- **Answers to all three questions**
 - It depends a lot on your soil
 - It depends on R_R

Optimum Use of Wire On / In Ground #14 Insulated THHN (House Wire)

Radials	16	24	36	60	90
Length (Ft)	51.5	64	77	103	128
Total Wire (Ft, \$)	825 \$66	1,550 \$124	2,800 \$224	6,200 \$496	11,500 \$920
Loss (dB)	3	2	1.5	1	0.5
R_{IN} Ohms	52	46	43	40	37

**Loss and Feedpoint impedance are for
 $\lambda/4$ vertical over average soil (K4ERO,
Dec '76, ARRL 2010 Handbook)**

SWR and Ground Losses

- It's quite difficult to get ground and wire losses below about 4Ω , and R_R above 35Ω
- At the feedpoint, we're measuring $R_R + R_W + R_G$
- As ground losses are reduced (more radials) SWR rises
- In this case, higher SWR is good!

Optimum Use of Wire On / In Ground #14 Insulated THHN (House Wire)

Radials	16	24	36	60	90
Length (Ft)	51.5	64	77	103	128
Total Wire (Ft, \$)	825 \$66	1,550 \$124	2,800 \$224	6,200 \$496	11,500 \$920
Loss (dB)	3	2	1.5	1	0.5
R_{IN} Ohms	52	46	43	40	37

**Loss and Feedpoint impedance are for
 $\lambda/4$ vertical over average soil (K4ERO,
Dec '76, ARRL 2010 Handbook)**

Optimum Use of Wire On/In Ground K3LC – $\lambda/4$ vertical over average soil

Radials	12	18	28	40	80
Length (Ft)	42	55.5	71.5	100	145.5
Total Wire (Ft, \$)	500 \$40	1,000 \$80	2,000 \$160	4,000 \$320	8,000 \$640
Gain (dBi)	0.1	.38	.63	.9	1.17

National Contest Journal March/April 2004

Computed from NEC4 Model

Optimum Use of Wire On/In Ground

K3LC – $\lambda/4$ vertical very poor soil

Radials	8	12	18	26	36
Length (Ft)	62.5	83.3	111	153	222
Total Wire (Ft, \$)	500 \$40	1,000 \$80	2,000 \$160	4,000 \$320	8,000 \$640
Gain (dBi)	-3.1	-2.5	-1.9	-1.2	-.5

National Contest Journal March/April 2004

Computed from NEC4 Model

Ground Screens Can Work

- **Some AM broadcasters use a heavy copper mesh, typically 40 ft square surrounding the tower, with radials connected at perimeter of the mesh**
- **Provides very effective shielding between antenna and earth where current density and magnetic fields are strongest**

Some Ground Screen Solutions

- **Use strips of 3-ft or 5-ft wide galvanized hardware cloth**
 - ~ \$350 for 600 sq ft, 19-gauge
- **Or strips of galvanized welded wire fencing 2" x 2" or 2" x 4" grid**
 - ~ \$ 150 for 600 sq ft, 14 gauge
- **Or strips of galvanized wire mesh, 1" x 1" squares**

1/2" Galvanized Hardware Cloth



1-in x 1-in Galvanized Wire Mesh



Some Ground Screen Solutions

- **If possible, lay strips out radially in four directions**
- **Use alternative layouts when it's the best you can do**
 - **A single strip, centered below the antenna if possible, or even two running parallel to each other**
 - **More is better**

Galvanized Hardware Cloth

- **Sources of 19-gauge, 1/2 in grid**
 - **3 ft x 25 ft \$50 Home Depot**
 - **3 ft x 50 ft \$75 amazon.com**
 - **3 ft x 100 ft \$108 Howard Wire, Hayward, CA (56#)**
- **Use a layout that fits your space**
 - **4 - 3' x 25' strips 300 sq ft**
 - **8 - 3' x 25' strips @ 45° 600 sq ft**
 - **4 - 3' x 50' strips 600 sq ft**

Galvanized Welded Wire Fencing

- **Home Depot, Lowe's, etc.**
- **Cheap! For 2" x 4" grid, 14 gauge**
 - 4 - 3' x 50' strips, 600 sq ft ~ \$120
 - 4 - 4' x 50' strips, 800 sq ft ~ \$160
 - 8 - 2' x 25' strips, 400 sq ft ~ \$80
- **For 1" x 2" grid, 14 gauge (Ace)**
 - 4 – 2' x 25' strips 400 sq ft ~ \$100
- **For 2" x 3" grid, 16 gauge (Ace)**
 - 4 – 3' x 50' strips 600 sq ft ~ \$136

Using Galvanized Wire Mesh

- Can be on the ground or buried**
- Don't try to solder to it, use mechanical connections**
- Avoid damage to the galvanizing**
- Join overlapping or adjacent strips at multiple points**
- All of these mesh options are OK for our purposes**

Galvanized Wire Mesh

- **Decent alternative to radials**
- **Compare 4 – 4 ft x 50 ft mesh strips to 60 radials the same length**
 - **Much higher density close to antenna where loss is greatest**
 - **Less density further from antenna**
 - **Performance could be close**

Counterpoise Systems

- Any end-fed antenna needs a path for return current, and for the fields produced by the antenna
- Radial systems are best, but not always practical
- A counterpoise is what we call another conductor that can sink the return current (but may not help much with the fields)

My Counterpoise in Chicago

The Shack

The Fence



160M Top-loaded Wire in Chicago



K2AV Folded Counterpoise

- **Designed as a solution for small lots – only 66 ft long x 8 ft high**
- **Easy to build**
- **Folded design places currents in overlapping segments out of phase with each other, so fields coupling to the earth partially cancel, reducing earth losses**

K2AV Folded Counterpoise

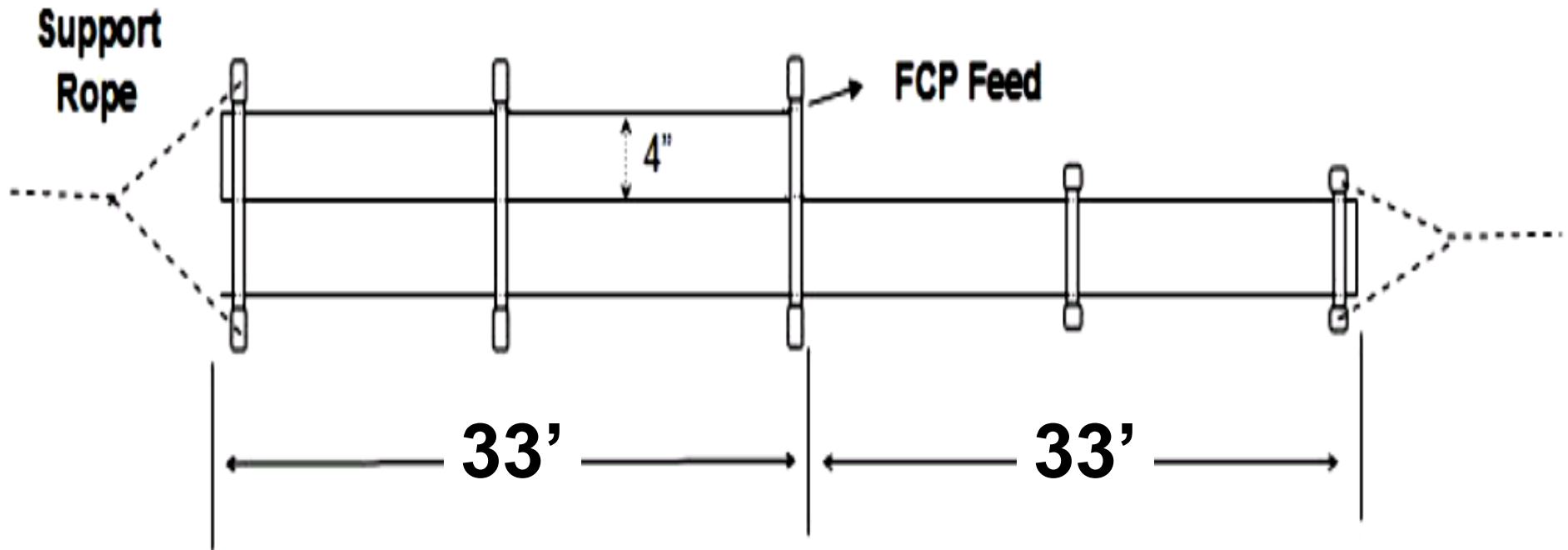

Dimensions for #12 bare or enameled copper, spaced 4 inches, 8 ft high
Use 1/2 inch PVC conduit for spreaders

K2AV Folded Counterpoise

- **K2AV says it's roughly equal to 4 elevated radials**
- **Requires 1:1 transformer, or K9YC feedline choke and loading coil**

K2AV Matching / Isolation Xfmr

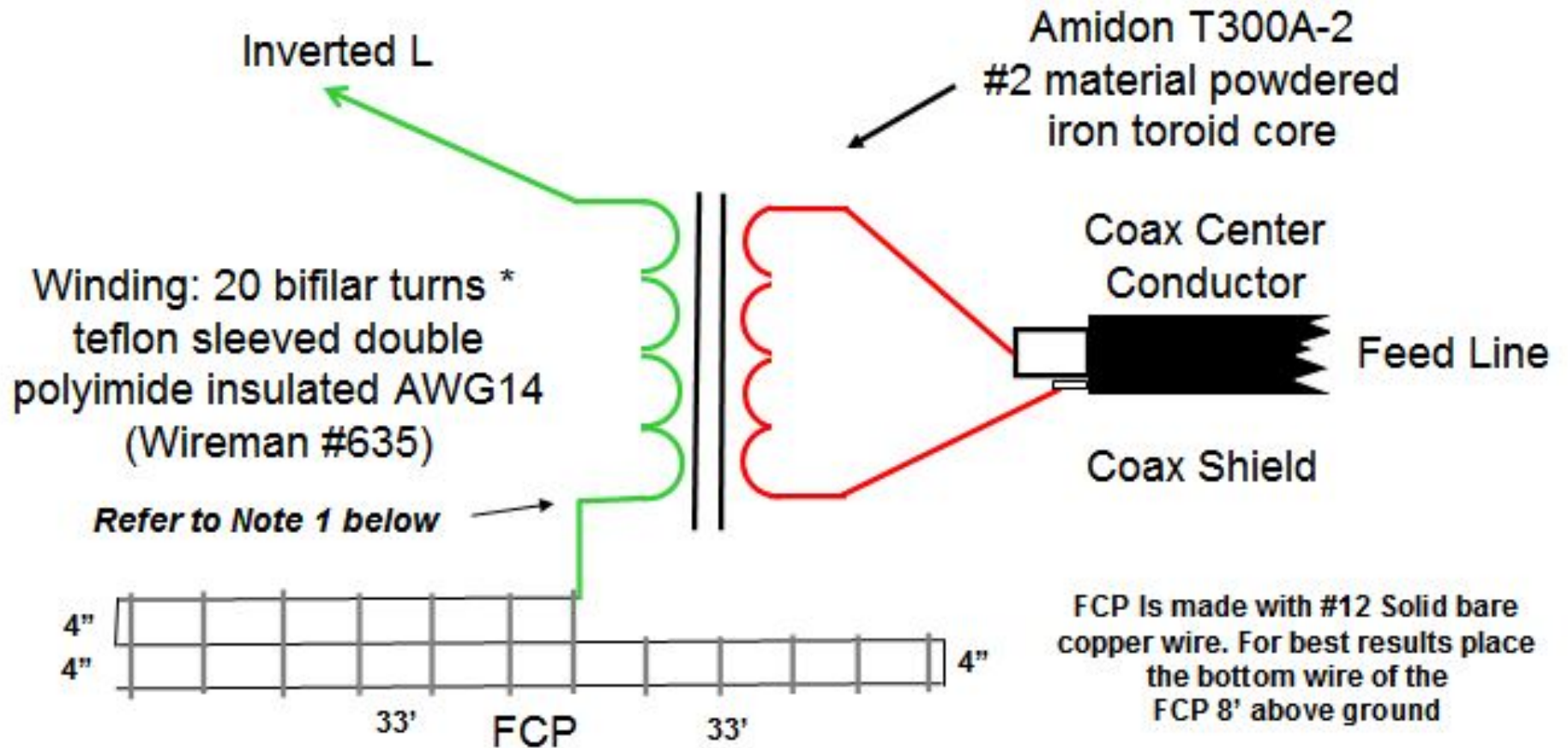

**A version of this transformer is sold by
Balun Designs (\$83 + shipping).
The K9YC method is much cheaper**

K2AV's Matching Method

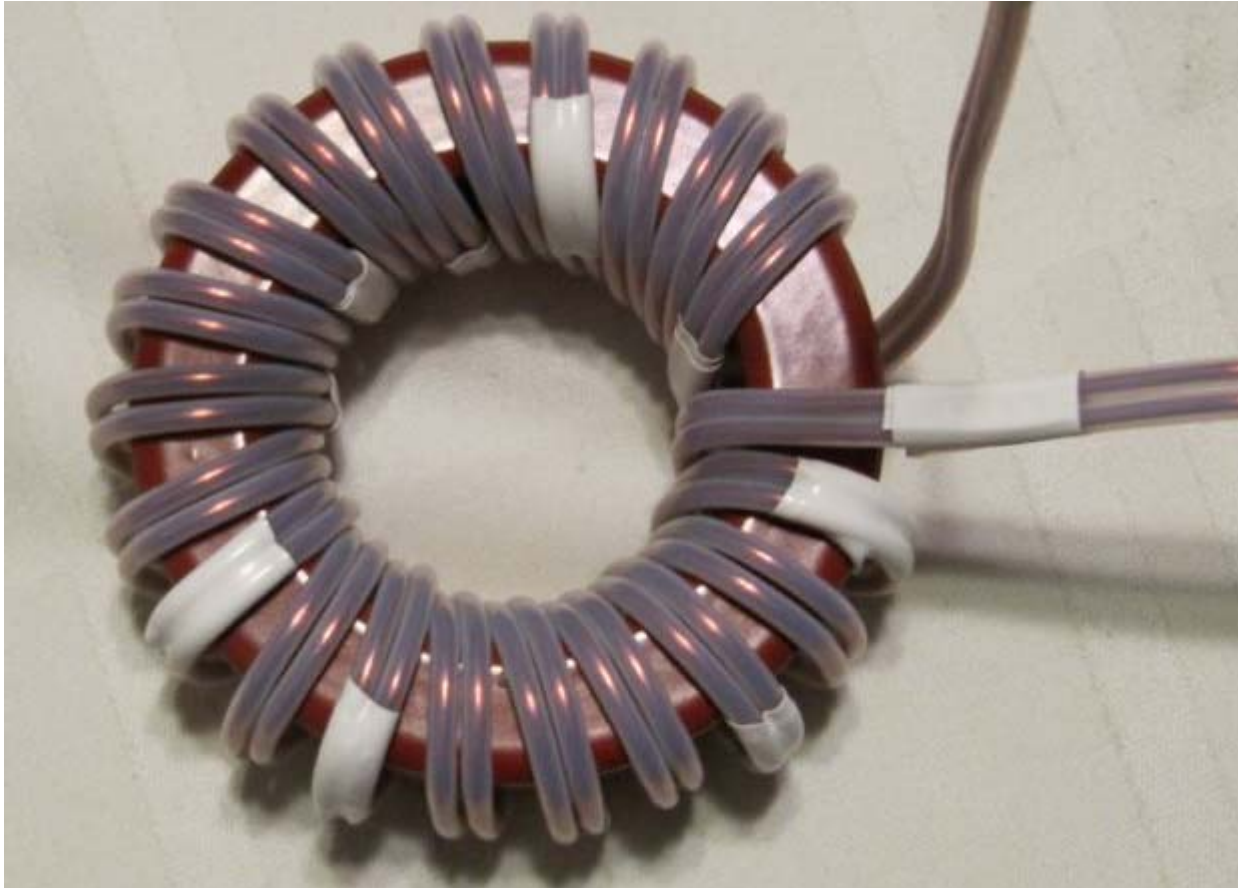

**12 bifilar turns #12 Teflon, on Amidon
T300A-2 #2 powdered iron core,
connected as a transformer, not a choke**

Transformer in Box

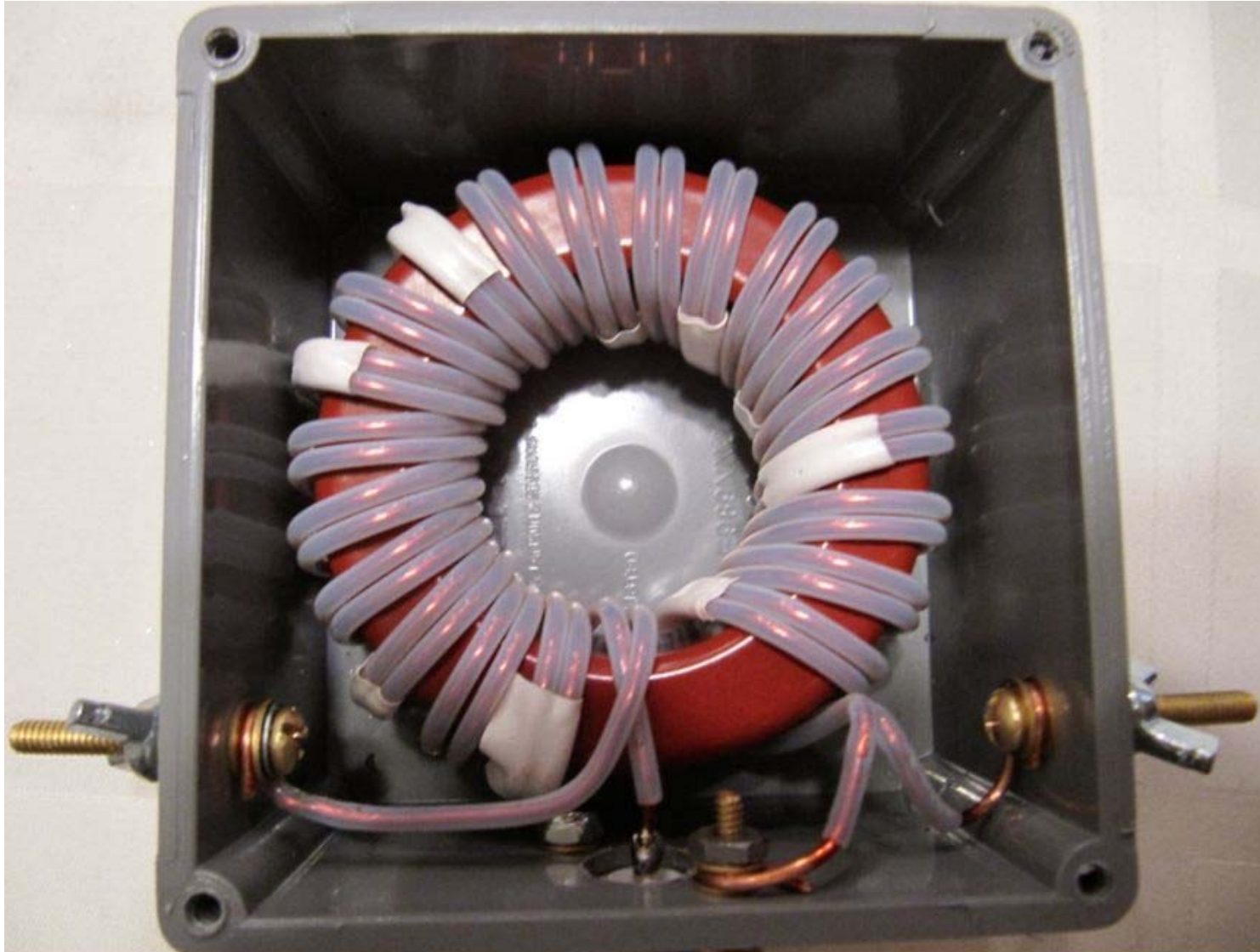

By K8OZ

K2AV Folded Counterpoise

- **K2AV says the FCP is ineffective without an isolation transformer, and that a ferrite choke will fry**
- **He's partly right, but there's more to it.**

W8JI's Analysis (Using NEC)

- The counterpoise is electrically short ($< \lambda/4$), so it needs series L**
- The K2AV-designed transformer has enough leakage inductance to provide that series L**
- The series L makes the FCP work better, and the transformer keeps common mode current off the coax**

K9YC's Analysis (based on W8JI's)

- The required series L can easily be provided by a simple loading coil wound on 4-inch PVC conduit**
- Any of my common mode chokes designed for 160M will keep RF off the coax**
- Both the inductor and the choke are needed – with no inductor, the antenna is badly unbalanced, and the choke will fry at high power**

K9YC's Analysis (based on W8JI's)

- Adding series L, either with the transformer or a loading coil provides the balance**
- W8JI says $X_C = 195\Omega$, so needed L is $\sim 17\mu\text{H}$, 13 close-wound turns of #10 THHN on 4-inch PVC conduit**
- Once the antenna is reasonably balanced, a good ferrite choke can handle the power**

Add Loading Coil Here

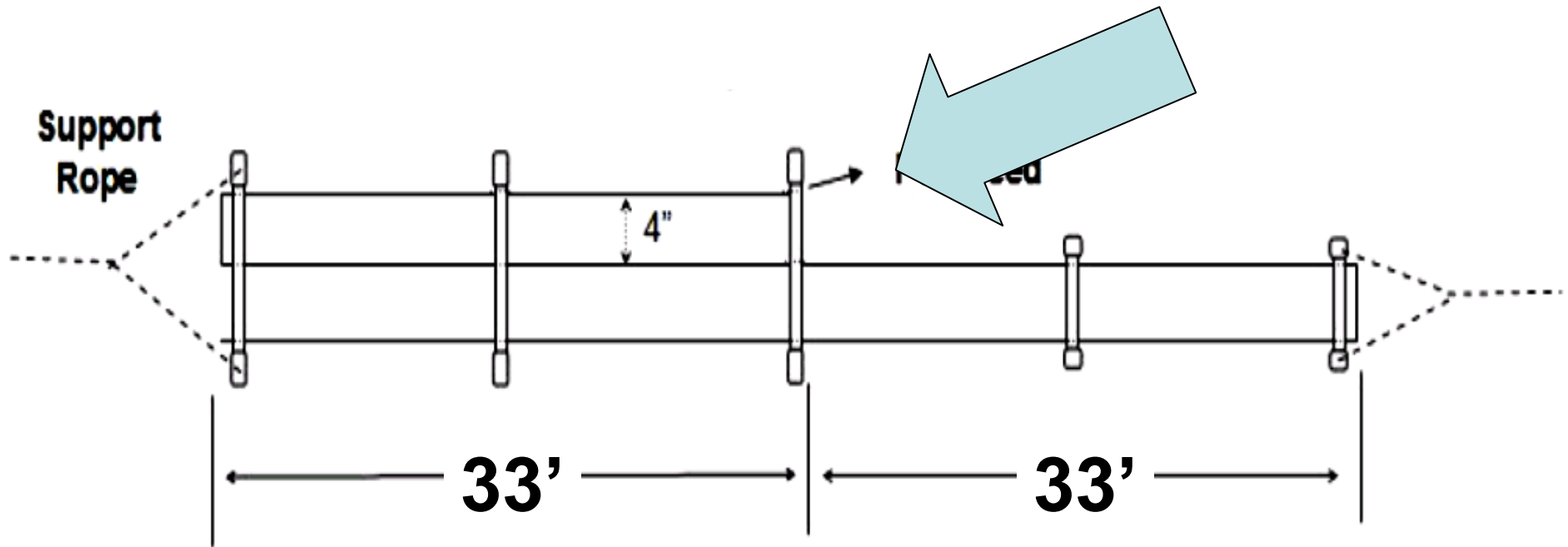

**Add loading coil between counterpoise
and coax shield and
Add K9YC ferrite choke to feedline**

Coax Choke for 160M



Coax Choke for 160M



Another Choke for 160M – 20M

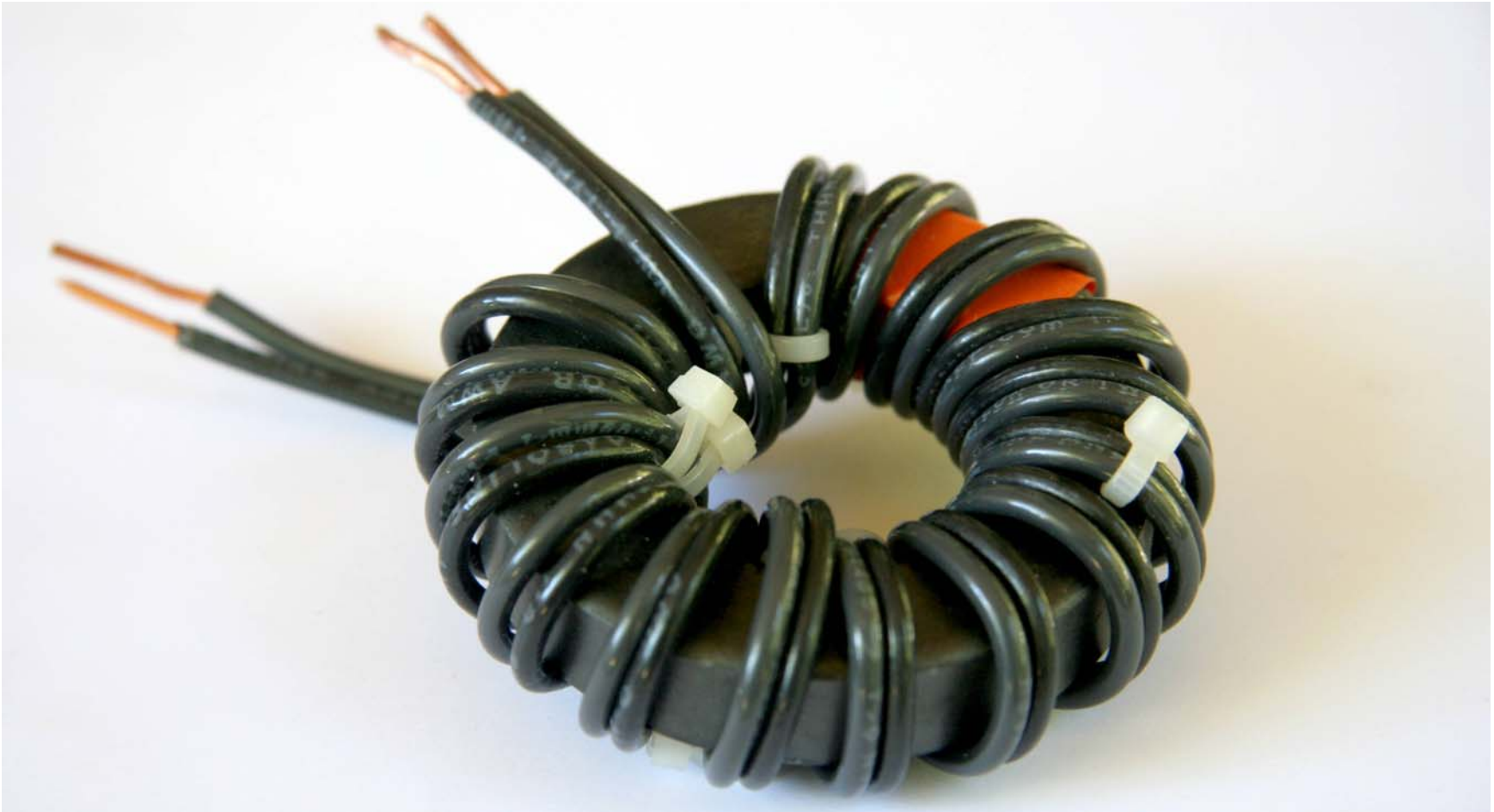

**16 bifilar turns #12 THHN on #31 core,
connected as parallel wire transmission
line between coax and antenna**

Using Your Tower on 160M

- **Load it as a vertical**
 - **See ARRL Handbook, ARRL Antenna Book for matching methods**
 - **Gamma match**
 - **Omega match**
- **Use tower to support one or more sloping wires, load the wire(s)**
 - **Some can produce gain**

Feeding a Tower on 160M

- **Ham towers are electrically longer than their physical height**
- **Resonant frequency is lowered by**
 - **Cross section of the tower**
 - **Top-loading of the boom and non-insulated elements of yagi antennas**
 - **Typical tri-bander or 3-el 20M Yagi is equivalent to 30-40 ft height**
 - **Less if some elements are insulated**

Feeding a Grounded Tower

- **Use NEC to find resonance**
 - **Add to the model all antenna elements, including booms, that are electrically connected to the tower (but not insulated elements)**
 - **Place a source at the base, connect base to ground, and compute SWR over the range of frequencies where you expect to find resonance**

Tower Resonance – An Example

- **My 45 ft tower has:**
 - **17 ft mast above tower**
 - **3-el 20M Yagi at top of mast**
 - **4-el 15M Yagi 10 ft below top of mast**
 - **Long boom 2M Yagi side-mounted just below rotator**
- **NEC predicts 2.1 MHz resonance**

Feeding a Grounded Tower

- **Using NEC to find resonance**
 - **Equation for equivalent diameter of triangular tower**
- D = Diameter of leg, F = face width**

$$\sqrt[3]{\frac{DF^2}{2}}$$

Grounded Tower Needs Radials

- **Base connected to lossy earth, is a poor RF ground**
- **Use on-ground or buried radials**
- **Radials also needed if you want tower to be a passive reflector**
 - **No radials means high resistance in series with tower, reducing current, killing the gain it could provide**
- **Ground screen also an option**

Hang A Sloping Vertical on Tower

- Mount 10 ft length 4-in PVC horizontally below rotator, use it to support sloping wire, insulated from tower**
- Feed wire as a vertical, adding top or base loading as required**
- Add radials, ground screen, or counterpoise at feedpoint**

Hang A Sloping Vertical on Tower

- **Depending on height, tower may act as passive reflector, providing gain in direction of slope**
 - **If so, tower needs on-ground radials**
 - **Follow on-ground guidelines**
 - **I'm getting nearly 5 dBi**
- **See K3LR's and N6LF's websites, ARRL Handbook, ARRL Antenna Book for more sloping wire ideas**

What To Do With More Space?

- A few of us are lucky enough to have space – I have 8 acres of redwoods**
- I hang wires from trees, run radials, both elevated and on the ground through the woods**
- Watch out for interaction. That 45 ft tower interacts with my 160M verticals, changing their pattern!**

On-Ground Radial Guidelines

- Use taller antenna, more and longer radials**
- Resonant length matters if you have only a few radials (<12), much less important if you have many**
- 95-100 ft is “in the ballpark” for THHN radials laying on the ground
–depends on soil conductivity, may vary throughout year with moisture**

On-Ground Radial Guidelines

- Connect opposing radials in pairs to antenna impedance meter (MFJ259, etc.) to find their resonance**
- Trim radials to make them resonant**
- Lengthening effect of soil will be greatest when soil is wet, so do your first trim when soil is dry**

Measured, 130 ft radials laying on average ground, $\lambda/4$ vertical

4 radials	\$42	0 dB
8 radials	\$84	0.8 dB
16 radials	\$168	1.2 dB
32 radials	\$336	2.1 dB
64 radials	\$672	2.4 dB

(Rudy Severns N6LF QEX Jul/Aug '09)

4 $\lambda/4$ radials or 100 $\lambda/4$ radials on ground – how much difference?

- **Over very good soil 3-4 dB**
- **Over average soil 5-6 dB**
- **Over poor soil 6-7 dB**

Measured by N7CL at many varied sites as a consultant to broadcasters and the military

Source: Topband reflector archives

Elevated Radial Systems

- **Good** – Four $\lambda/4$ radials elevated at least 18 ft (not shortened by V_F)
- **Better** – Increase number to 8-16
- **Height matters** – elevated radials don't work very well unless they are at least 16 ft high, higher better
- **Symmetry matters** – differences can greatly increase loss

Symmetry of Elevated Radials

- **Most important if only 4 radials**
- **Soil under radials varies, causes asymmetry**
- **Small differences can cause major imbalance in currents, greatly increasing ground loss**
- **Using more radials minimizes the effects of asymmetry**

To Minimize Asymmetry Losses

- Connect elevated radials only to coax shield, never to ground rod
- Always use a serious ferrite choke on the coax
- Insulate the ends – up to 2 kV can be present at high power

Elevated Radials in Limited Space

- **Shorter radials can work if:**
 - There are many of them
 - They are equal in length
 - They are equal in height
 - They are equally spaced
 - They are high (at least 16 ft)
- **If you can't satisfy this, use on-ground radials, wire mesh, or a counterpoise**

A Simple Match for a Longer Wire

- As a wire is made longer than $\lambda/4$, R_R gets larger and the antenna looks inductive**
- If space permits, rig a wire long enough that $R_R + R_W + R_G = 50\Omega$**
- Add a series capacitor to tune out the inductance**
 - Use HV capacitors from HSC if you want to run high power**

How Much Capacitance?

- **Method #1: In NEC model, find X when $R = 50\Omega$, compute C**
- **Method #2: Measure feedpoint Z to get X , compute C**
- **Method #3: Trial and error – add series C until $SWR = 1:1$**
- **All three work, #1 and #2 are faster and less work**

Capacitors to Handle High Power

- An important characteristic of any capacitor is its *Equivalent Series Resistance (ESR)*
- ESR burns power (I^2R)
- current is highest at the feedpoint, so cap with high ESR will fry
- Caps with higher voltage rating may have lower ESR, but not always

Capacitors to Handle High Power

- **HSC has a good selection of HV disc ceramic caps, but not all have low ESR**
- **They're cheap, so buy a selection and try them**
- **Add caps to resonate the antenna, transmit keydown for a while, stop transmitting, and feel the cap**
- **If cap(s) are cool (or slightly warm), ESR is low enough**

Capacitors to Handle High Power

- **Temperature coefficient (TC)**
 - How much capacitance change in parts per million per degree C
 - N750 = -7.5% for 100 C° temp rise
 - NPO = no change (expensive)
- **Good low cost HV caps often have a high TC, work fine if low ESR**
- **Resonance goes up slightly winter to summer, or if the cap gets hot**

Some High Voltage Caps That Work Well



How Important is Matching?

- **Losses on 160M are quite low in any decent RG8, even when not perfectly matched (~ 0.25dB/100 ft)**
 - **A 3:1 match at the antenna is plenty good enough unless the run is quite long (>250 ft) with a decent tuner in the shack**
- **Worry about matching only to make your power amp happy**

Receiving Antennas

- **You can't work them if you can't hear them**
- **All serious 160M operators take RX antennas seriously**
- **Loop and flag antennas reject some noise, some have directivity**

Receiving Antennas

- **These are best if there's space**
 - **Beverages**
 - **Phased arrays of verticals**
- **For limited space**
 - **K9AY loop, Waller flag**
 - **N6RK has a nice feed system for magnetic loop**

References

- **ARRL Handbook**
- **ARRL Antenna Book**
- **ON4UN Low Band Dxing**
- **N6LF website**

<http://www.antennasbyn6lf.com>

- **N6RK website www.n6rk.com**
- **K9AY loop www.aytechnologies.com**

References

- Waller Flag www.n4is.com
- K3LR Website www.k3lr.com
 - K9RS 2008 Dayton Antenna Forum
 - NC0B 2009 Dayton Antenna Forum
- NC0B on Ground Screens (*Ham Radio May 1977*)

<http://www.sherweng.com>

Working 160M From a Small Lot (and Larger Ones Too)

Jim Brown K9YC

k9yc@arri.net

<http://audiosystemsgroup.com/publish.htm>